

SEC SYLLABUS (2011)

GRAPHICAL COMMUNICATION

SEC 29

SYLLABUS

Graphical Communication SEC 29 Syllabus

(Not available in September)
Paper 1 (2 hrs)+Paper 2 (2hrs)

SYLLABUS OBJECTIVES

- Develop the ability to interpret, reason and communicate graphically;
- Foster an awareness of the importance of Graphical Communication as an international language;
- Stimulate an interest in, and enjoyment of, the study of graphical techniques and their application;
- Develop the ability to use a range of draughting techniques;
- Contribute to pupils' personal development and overall education;
- Form an appropriate introduction to relevant further studies (intermediate and advanced level etc.)

MAIN ASSESSMENT OBJECTIVES

1. Knowledge of:
 - a) Drawing equipment.
 - b) Constructions, terminology and conventions applicable to the subject.
 - c) Principles of orthographic and pictorial projections.
2. Comprehension:
 - a) Interpret the information given (verbally, written, graphically or a combination of two or more), so as to represent design concepts.
 - b) Consider and represent plane and solid shapes.
 - c) Understand and visualize spatial relationships.
3. Application:
 - a) Produce suitable drawings from information presented.
 - b) Apply the principles of plane and solid geometry to the solution of problems.
 - c) Apply the principles of orthographic and pictorial projections.
4. Analysis:
 - a) Compare and use the appropriate graphical methods of communicating information and ideas.
 - b) Analyse and solve a problem graphically.
5. Technique:
 - a) Accuracy in questions answered.
 - b) Ability to sketch freehand and in good proportions.
 - c) Present quality draughtsmanship (presentation, cleanliness, finishing, spacing, etc.)
 - d) Use available aids and media to enhance the presentation where appropriate.

The subject content shall be weighed against the assessment objectives.

SCHEME OF ASSESSMENT

The examination will consist of two papers of two hours duration each. Each paper will contain between five and seven questions. The candidates must satisfy the examiners in both papers. Any examination question can test material from more than one topic. The questions will be set in English. Calculators are allowed.

- Paper 1 will carry 50% of the total marks. Candidates will be expected to attempt all questions
- Paper 2 will carry 50% of the total marks. Candidates will be expected to attempt all questions

There will be two versions of Paper 2: Paper 2A and Paper 2B. Questions in Paper 2A will be more difficult than those in Paper 1. Questions in Paper 2B will be easier than those in Paper 1. Candidates are required to indicate on the registration form which Paper 2 they wish to sit for. No change in the choice of paper will be allowed after registration period.

ASSESSMENT CRITERIA

- **Drawing Skills.** Drawing skills should be developed in order to present precise and accurate information. It must be recognised that draughting skills is a means to a general end and not an end in itself.
- **Layout.** Good layout of drawings is required to achieve visual impact and clarity. Although the candidates are expected to be capable of using draughting aids such as trammels, arc ends, ellipse aids, curve aids (French and flexi curves), letter stencils, different colouring media and the like, their use may be restricted in the examination for obvious reasons.
- **Use of Instruments.** The effective use of instruments and aids are required to achieve good draughting techniques.
- **Lettering.** Only the use of freehand techniques will be accepted unless otherwise stated. The selection and positioning of letters and figures of suitable scale is required. The criteria should be clarity, proportion and uniformity in presentation. This is achieved by the use of block single stroke upright style capital letters and figures.
- **Presentation.** The effective use of various techniques of shading, colouring and other techniques for emphasis, using pencils and crayons. Candidates should be aware of the value of relative line thickness and density. Candidates should also be able to select the most effective method of graphical illustration; for instance whether to draw freehand or use instruments, or whether to employ orthographic or pictorial projections.

RESULTS

Candidates sitting for Paper 1 and Paper 2A may qualify for grades 1,2,3,4 and 5. The results of candidates who do not obtain at least a grade 5 shall remain unclassified (U). Candidates sitting for Paper 1 and Paper 2B may qualify for grades 4, 5, 6 or 7. The results of candidates who do not obtain at least a grade 7 shall remain unclassified (U).

The following grade descriptors indicate the level of attainment characteristic of the given grade at SEC level. They provide a general indication of the required learning outcomes. The descriptors should be interpreted in relation to the content outlined in the syllabus.

GRADE DESCRIPTIONS

Grade descriptions are provided to give a general indication of the standards of achievement likely to have been shown by candidates awarded particular grades. The grade awarded will depend upon the extent to which the candidate has met the Assessment Objectives overall and it might conceal weakness in one aspect of the examination which is balanced by above average performance in some other.

GRADE 7

The candidate:

1. demonstrates the ability to recall simple facts, common terms, principles and conventions contained in the Subject Content;
2. translates from oral or written instructions into graphic form with some features correctly drawn;
3. translates from one form of pictorial presentation to another with some degree of success;
4. applies the principles of orthographic projection inconsistently;
5. applies the principles of plane and solid geometry with little success;
6. demonstrates a limited knowledge of graphical techniques and is inconsistent in the interpretation of data;
7. has difficulty comparing different methods of graphic presentation in order to select the most appropriate;
8. produces untidy and inaccurate freehand sketches;
9. displays faulty draughting technique resulting in undifferentiated line quality and lack of accuracy;
10. uses colour carelessly, tending to obscure detail;
11. may not complete all set tasks.

GRADE 5

The candidate:

1. demonstrates the ability to recall many facts, terms, principles and conventions contained in the Subject Content;
2. translates from oral or written instructions into graphic form with few details omitted or incorrect;
3. translates from one form of projection to another with few misconceptions;
4. applies the principles of orthographic projection with few errors;
5. applies the principles of plane and solid geometry with limited success;
6. demonstrates the ability to interpret data with a fair degree of accuracy and generally uses an appropriate graphical representation;
7. compares different methods of graphic presentation and selects that which is appropriate;
8. sketches freehand to produce a recognizable drawing;
9. uses drawing instruments and aids to produce mainly accurate drawings but possibly with variable line quality;

10. demonstrates a reasonable use of colour, shading, and other media to improve the quality of presentation;
11. completes most set tasks.

GRADE 1

The candidate:

1. demonstrates the ability to recall most facts, terms, principles and conventions contained in the Subject Content;
2. translates from oral or written instructions into graphic form with a high degree of accuracy;
3. translates from one form of projection to another successfully;
4. applies the principles of orthographic projection correctly;
5. applies the principles of plane and solid geometry appropriately;
6. demonstrates the ability to interpret data accurately and use the appropriate graphical representation with competence;
7. compares different methods of graphic presentation and uses that which is most appropriate;
8. sketches freehand in good proportion to represent given information accurately;
9. uses drawing instruments and aids to produce accurate drawings with clear and consistent line density;
10. demonstrates the skilful use of colour, shading and other media in enhancing the clarity of presentation;
11. completes all set tasks.

GENERAL

- 1) The questions in both papers will be printed on answer sheets, which may include pre-printed partly drawn solutions. Written solutions may be required.
- 2) The exam papers shall consist of A3 sheets.
- 3) Candidates are to provide their own drawing equipment.
- 4) Questions shall be set in SI units and reference should be made, as appropriate, to the following publications of the British Standards Institution.
 - i) PP 8888 Engineering drawing practice for schools and colleges [excluding section 14-toleranced dimensions]
 - ii) Other related ISO standards.

SUBJECT CONTENT

Paper 1

1. Plane Geometry

- *Geometrical Constructions*

- Construction, bisection and division of lines, angles and erection of perpendiculars.
- Division into equal or proportional parts.
- The construction of angles by the continuous bisection of 90° , 60° , 45° and multiples thereof, without the use of the protractor.
- Triangles:
 - *Properties*
 - *Construction of triangles, given:*
 - 3 sides
 - 2 sides and their included angle
 - Base, one base angle and the length of the side opposite the base angle
 - Base and the 2 base angles
 - The base of an equilateral triangle
 - The altitude of an equilateral triangle
 - Base and altitude of an isosceles triangle
 - Length of one side/angle and hypotenuse of a right angle triangle
 - 2 base angles and the altitude
 - Altitude and apex angle of an isosceles triangle
 - Perimeter and the ratio of the 3 sides
 - Perimeter and altitude of an isosceles triangle
 - Perimeter and the 2 base angles
 - Perimeter, base and base angle
 - Base angle, apex angle and altitude

-Inscribed, Circumscribed and Escribed

-Pythagoras Theorem and its application

in relation to other regular figures

- Properties and Construction of Quadrilaterals.
- Properties and Construction of Irregular Polygons.
- Properties and Construction of Regular Polygons.
 - The construction of regular polygons on a given line or in circle.
 - Regular polygons restricted to pentagon, hexagon, heptagon, octagon, and nonagon.
- Linear enlargement or reduction of figures: Radial/ Pole, and Proportional Scale methods included.
- Determination of Areas of Plane Figures by:
 - Mid-ordinate Method
 - Division into squares and parts of.
- Construction of figures having the same area of another given polygon.

- *Scales* Construction and application of simple/plain and diagonal scales
- *Circles*
 - a) The parts of a circle-circumference, diameter, radius, quadrant, sector, arc, segment and semicircle.
 - b) Finding the centre of a circle. Concentric and eccentric circles.
 - c) Construction of straight lines and arcs, tangential to other arcs.
 - d) Circles, which touch or intersect.
 - e) Construction of circles to pass through given points, and tangential to given lines.
 - f) Points of tangency should be established in all the above.
- *The Ellipse*
 - a) Construction of an ellipse
 - b) Construction of a normal and tangent to an ellipse, to be able to draw circles and straight lines tangential to an ellipse
 - c) Construction methods to include:
 - Auxiliary circles - concentric circles
 - Radial interceptors – intersecting lines -rectangle
 - Intersecting arcs - foci
 - Compasses - approximate method
 - Trammel
 - Loop of Thread/ Pin and Thread

N.B. Trammel, Loop of thread and Compasses – approximate method are not considered as construction methods.

- *Loci* The loci of simple coplanar moving parts: to include circular and reciprocating motion.

2. Solid Geometry

- a) Representation of right prisms, right cylinders, right pyramids and right cones.
- b) Sections and true shape of solids mentioned above at set square angles to principal planes. Both section and radial methods are to be considered
- c) Developments related to the above
- d) True lengths of lines and their true angles to the V.P. and H.P.
- e) True shape of triangular laminae

3. Orthographic Projection

- a) First and third angle orthographic projection including their symbols.
- b) Sectional views including: whole, half sections, part (scrap), revolved, removed and staggered (offset).
- c) Parts and features of parts **not normally sectioned**. (i.e. longitudinal cutting planes). Webs, ribs, spokes, shafts and similar parts, cut/sectioned along their axis **are not** to be shown in section.
- d) Parts and features of parts **normally sectioned**. (i.e. transversal cutting planes). Webs, ribs, spokes, shafts, tubes and similar parts, sectioned across their axis **are** to be shown in section.
- e) Simple assemblies from:

- Exploded views projected in line
 - Assembled pictorial views
 - Orthographic views
 - A combination of the above
- f) Dimensioning and commonly used conventions.
List of Conventions – Appendix 3.
- g) Scaled drawings.
Specimen example of Title/ Name Block – Appendix 1.
- h) Freehand drawings: Candidates will be expected to be able to produce drawings which are clear, well proportioned and suitably scaled, in orthographic projection without the use of instruments.
- i) **Tolerancing will not be required.**

4. Pictorial Projection

- *Isometric* Construction of isometric views including circles and arcs by either the use of a grid, ordinates or compasses methods. Isometric scale not included.
- *Oblique* To be in cabinet form with the 3rd axis at 45° and half true length.
- *Planometric* Receding edges of the object to be either 45° / 45° or 30° / 60°. In the case of 45° / 45°, the height may be reduced to $\frac{3}{4}$, $\frac{2}{3}$, or $\frac{1}{2}$, depending on height of object.
- *Perspective* Single and two point perspective drawings which are clear and well-proportioned. Estimated Perspective only is required. Dividing into equal parts by the use of diagonals is required.
Worked example of a two point Perspective view-Appendix 4.
- *Freehand* Candidates are expected to be able to produce shaded or unshaded drawings which are clear, well-proportioned and suitably scaled in all the above mentioned pictorial projections.

Paper 2

Paper two may cover aspects from Paper one and will also include the following:

1.Plane Geometry

- *Loci*
 - a) The cycloid
 - b) The involute of regular and irregular figures
 - c) Simple Archimedean spiral
 - d) The helix and its application including line, band/ribbon and circular – in – section springs.
- *Vectors* Simple concurrent, coplanar vectors: including triangle and polygon of forces.

2. Solid Geometry

- *Interpenetrations* Lines of intersection between prisms and cylinders and their combination. Interpenetration is to be restricted to solids, whose axes are perpendicular. These axes may either lie in the same vertical plane or offset, but always parallel to the vertical plane. Developments included.

3. Orthographic Projection

- *Auxiliary projection* First auxiliary views of simple objects projected at set square angles.

4. Design

- a) Knowledge, understanding and application of design as a communication tool.
- b) Design in relation to graphical presentation.
- c) Ability to visualise objects and shapes, and to design objects having particular functional requirements.
- d) Simple analysis of required design from given data.
- e) Design requirements to be related only to articles commonly found within the school or local environment.
- f) Layout of drawings and other graphical media from the viewpoint of aesthetics with clarity of presentation and maximum information content.

Other Design areas to include:

- a) Logos – simple logos from given data with the possibility of exploring different ideas and then to identify and develop the final logo. The proper use of colours/ shading is expected.
- b) Ideograms and symbols – simple ideograms from given data with the possibility of exploring different ideas and then to identify and develop the final ideogram. The proper use of colours/ shading is expected. The following standard types of signs are to be included: mandatory, warning, prohibition, general and safe condition.
List of safety signs – Appendix 2.
- c) Graphs and charts – Simple line, bar, column, histograms, pie, percentage bar, pictograms and other unconventional charts. Pictorial graphs/charts may be included. Pictorial pie charts to be

either oblique or planometric. The candidates should include a key where appropriate.

- d) Flow charts – simple data processing of practical nature and may include the following symbols: terminals, process, input/output, decision and connectors BS 4058.
- e) Electrical/Electronic circuits – To transform pictorial representations of electrical circuits into circuit diagrams using given symbols.

List of Electrical/Electronic symbols - Appendix 5.

6. Computer Graphics

The use of computer as an aid to draughting

The candidates will be expected to follow a sequence of computer commands for creating graphic images on a pre-printed grid which represents the graphic display (resolution 1200 x 1200).

1) Candidates are to draw the image produced by the given program on the starter sheet and be familiar with common terminology (commands) and techniques:

- a) Lines have a starting and a finishing point, direction, can be interpreted in colour and joined to produce drawings.
- b) Draw command draws a line from a current location to a given location.
- c) Move command moves the cursor from a current location to a given location without drawing a line.
- d) Mirror creates a mirror image of the figure/object. It is used for creating a symmetrical figure/object about a line of symmetry.
- e) Copy provides an ability to copy figures/objects from one drawing to another as well as within a single drawing.

2) Be familiar with:

- a) methods for inputting graphical data by the use of a keyboard and mouse;
 - b) methods for storing graphical data on a hard disc, floppy disc, USB Flash Memory Drive and CD-ROM;
 - c) methods for executing graphical data using printers;
 - d) Cartesian system;
 - e) the types of computer display used in graphics;
 - f) interpretation of the line/figure using the command AutoCAD Index Number (ACI No.) an integer from 1 to 255;
- Specimen question/answer – Appendix 6.*

Book list

This list is not meant in anyway to be prescriptive, but includes books which may be helpful.

Graphical Communication Book 1 / 2	A. Yarwood
Graphical Communication Book 1 / 2	S. Bland
Technical Drawing Bk.1-4	F.B. Mayock
Starting Graphics and Design	K. Balkham, R. Mills
Geometric and Engineering Drawing	K. Morling
Information Graphics	B. Purves
Manual of Engineering Drawing	C. Simmons, D. Maguire
Technical Draughtsmanship	ÉANNA O Broin

Specimen of Title/Name Block

Appendix 1

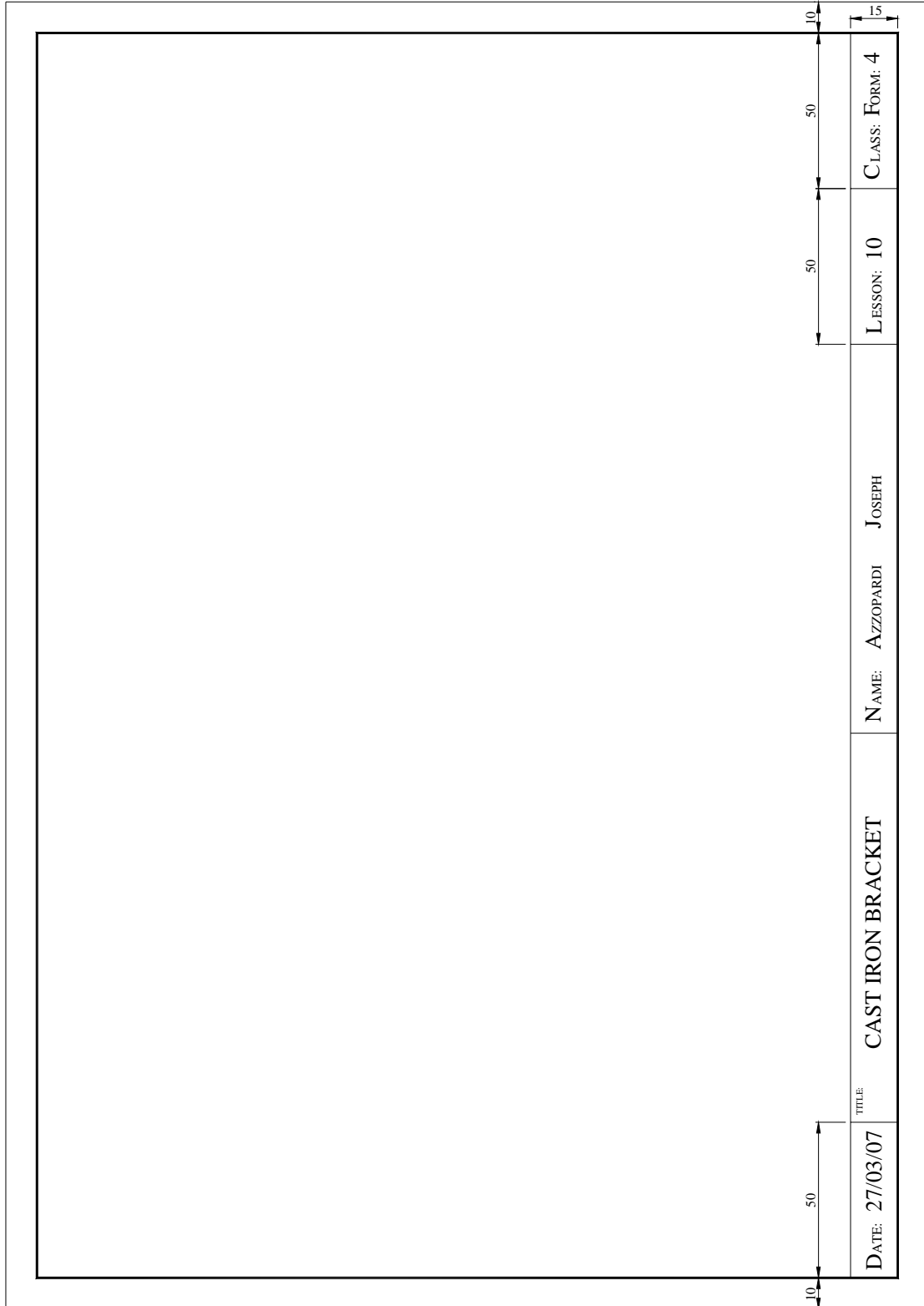

Key to British and European Standard Safety Signs

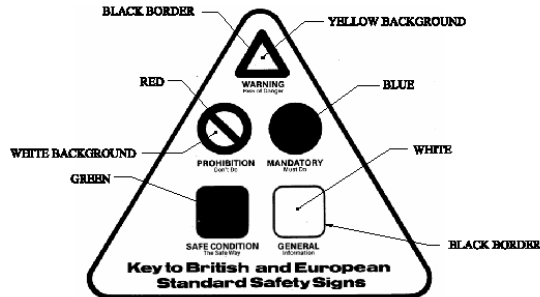

The symbol chosen is to be drawn partially or totally in Black as necessary

The principles of colour and design for the different types of safety sign adopted by BS5378

PROHIBITION SIGNS

All prohibition signs are red and white. These signs contain a red circle with a diagonal line through it, and the lettering is white upon a red background mounted on white.



List of Safety signs

Appendix 2

WARNING SIGNS

All warning signs are based upon the colours black and yellow, with the main instruction always being printed in black on a yellow background.



List of Safety signs

Appendix 2

MANDATORY SIGNS

All mandatory signs are based upon a blue background with white instructions.





SAFE CONDITION SIGNS

All safe condition signs have a green background with the instruction always in white.

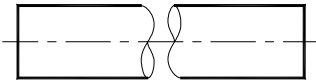
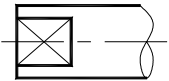
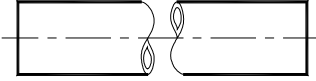
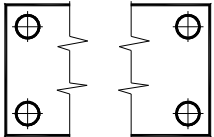
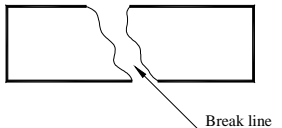
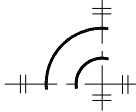
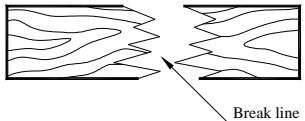
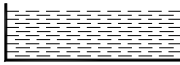

CONVENTIONAL REPRESENTATIONS

 <p>Conventional break lines for solid shaft</p>	 <p>Flat portion on a Shaft</p>
 <p>Conventional break lines for hollow shaft (Tube)</p>	 <p>Limits of partial or interrupted views and sections, if the limit is not an axis</p>
 <p>Rectangular section</p> <p style="margin-left: 100px;">Break line</p>	 <p>Symmetrical either side of centre line</p>
 <p>Wood</p> <p style="margin-left: 100px;">Break line</p>	 <p>Liquid - water</p>
 <p>Concrete</p>	 <p>Glass</p>

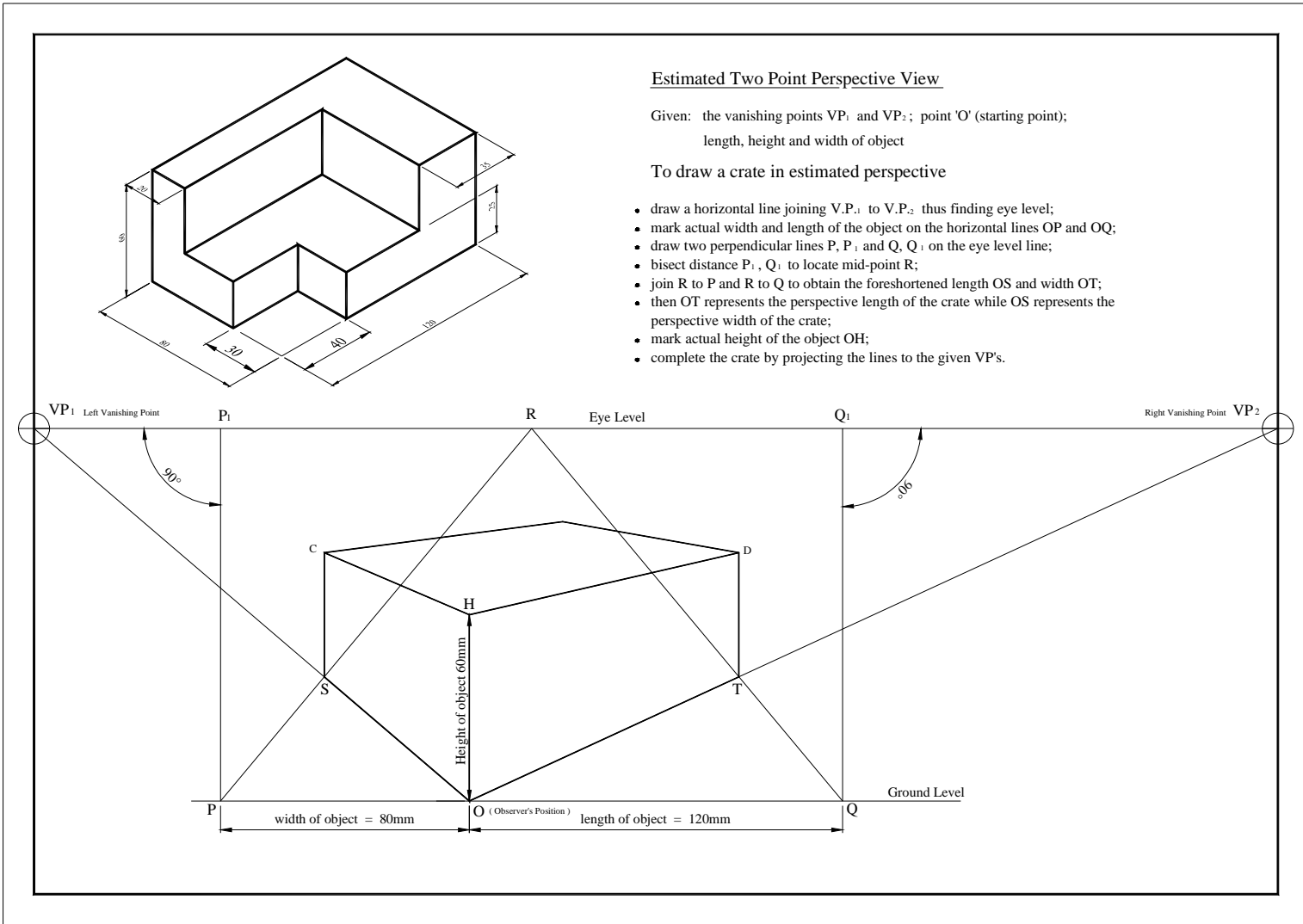

PROPORTIONAL SCALES:

To obtain the widths of the component

- draw the diagonal OC;
- with O as centre and OH as radius, draw arc to intersect the line O, VP₁ at V;
- join V to P;

To obtain the 30mm width.

- mark O-W horizontally 30mm long;
- draw WY parallel to PV;
- with centre O and OY as radius draw an arc to obtain Z;
- join Z to VP₁ to intersect the diagonal OC at A;
- draw AB parallel to CS;
- then OB is representing the foreshortened 30mm width.

NOTE: repeat the same procedure to obtain the other widths

To obtain the lengths of the component.

- draw the diagonal OD;
- with O as centre and OH as radius (height of object);
- draw arc to intersect the line O, VP₂ at J;
- join J to Q

To obtain the 40mm length

- mark O-K horizontally 40mm long;
- draw KL parallel to JQ;
- with centre O and OL as radius draw an arc to obtain M;
- join M to VP₂ to intersect the diagonal OD at N;
- draw NU parallel to DT;
- then OU is representing the foreshortened 40mm length.

NOTE: repeat the same procedure to obtain the other lengths.

Estimated Two Point Perspective View

PROPORTIONAL SCALES: Same principle, alternative method.

To obtain the widths of the component

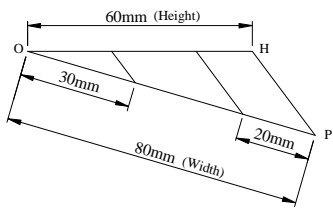



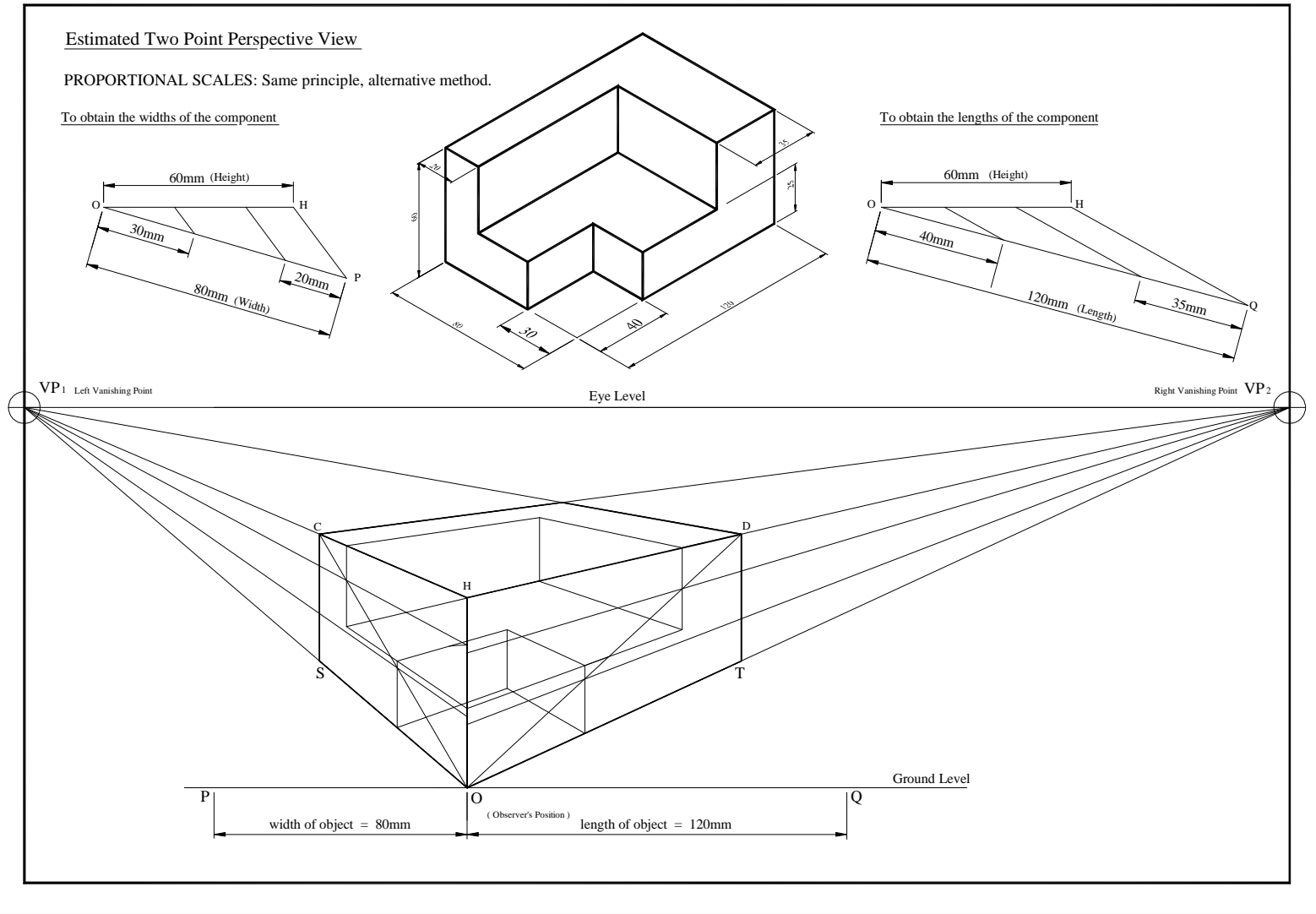
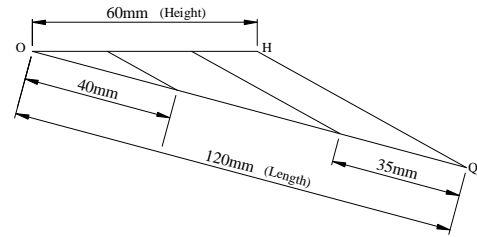







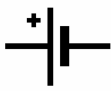
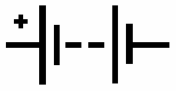

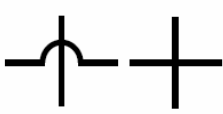
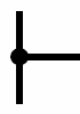
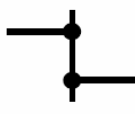

To obtain the lengths of the component

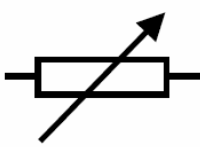
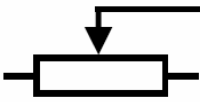
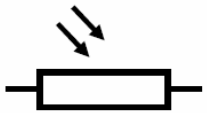





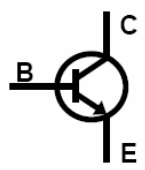
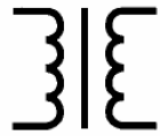







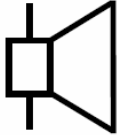

List of Electrical/Electronic circuit symbols

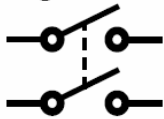
Appendix 5

The following is a selection of symbols used in electrical / electronic circuit diagrams according to B.S.I. Publication BS 3939 EN 60617.

<p>Cell</p> 	<p>Series of Cells (Battery)</p> 	<p>AC Supply</p> 	<p>Earth</p> 
<p>Fuse</p> 	<p>Crossing Conductors</p> 	<p>Junction of Conductors</p> 	<p>Double Junction</p> 
<p>Resistor</p> 	<p>Variable</p> 	<p>Potentiometer</p> 	<p>Light Dependent Resistor (LDR)</p> 
<p>Heating Element</p> 	<p>Indicator Lamp</p> 	<p>Filament Lamp</p> 	<p>Light Emitting Diode</p> 
<p>Diode</p> 	<p>Transistor</p> 	<p>Transformer</p> 	<p>Choke</p> 

<p>Capacitor</p> 	<p>Electrolytic Capacitor</p> 	<p>Variable Capacitor</p> 	<p>Arial</p> 
<p>Buzzer</p> 	<p>Bell</p> 	<p>Loudspeaker</p> 	<p>Microphone</p> 
<p>Switch</p> 	<p>Switch Double Pole Single Throw</p> 	<p>Switch Push to Make</p> 	<p>Switch Push to Break</p> 
<p>Motor</p> 	<p>Voltmeter</p> 	<p>Ammeter</p> 	

*Specimen Question**Appendix 6*

A computer graphic program uses the instructions DATA, MOVE & DRAW to generate an image in the following way:

DATA: A = 300: B = 400: C = 500: D = 600: E = 700: F = 800: G = 900

ACI 4: MOVE A,D: DRAW D,A: DRAW C,D:
MOVE E,D: DRAW D,A: DRAW G,D: DRAW A,D:

ACI 2: MOVE A,D: DRAW B,E: DRAW C,D: DRAW D,E:
DRAW E,D: DRAW F,E: DRAW G,D:

ACI 3: MOVE B,E: DRAW F,E:

The DATA statement specifies the numeric values (in pixels) of given variables. MOVE positions the cursor at the given location without drawing a line. DRAW draws a line from the current location given by the variable. The instruction ACI (AutoCAD Colour Index Number) will change those images that follow the instruction into a colour that is given by the number.

The computer responds to the following colour commands:

Colour	(ACI) Colour Index Number
Yellow	2
Green	3
Blue	4

The above program has been written in response to a design brief requiring a trade symbol for a new Jewellery company called Diamonds.

The starter sheet provided shows a pre-printed grid which represents the graphical display (1200 x 1200). Use the grid to draw the image produced by the above program.

Specimen Question

Appendix 6

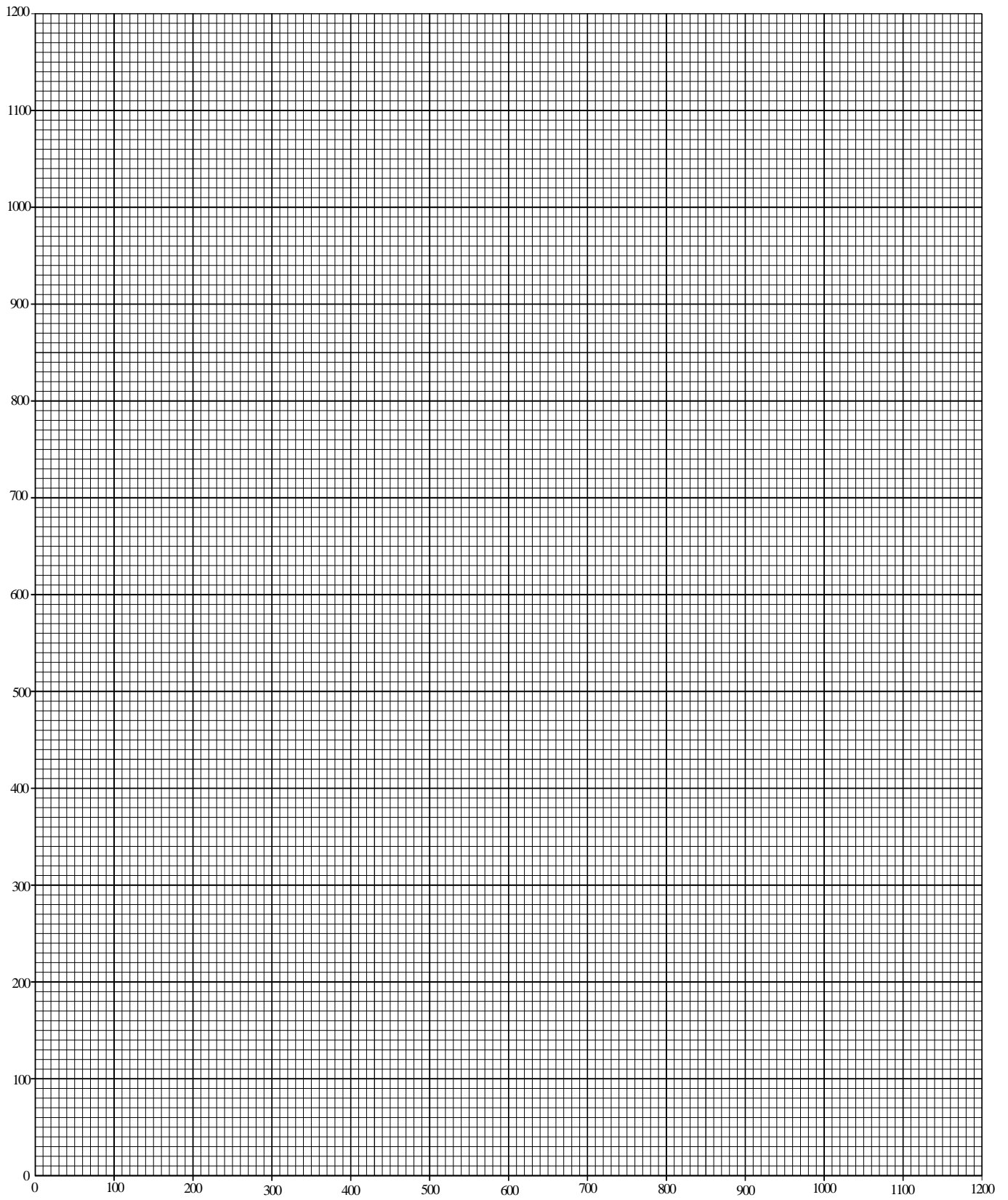

Specimen Answer

Appendix 6

